

PLUMBING FLASHINGS FOR RESIDENTIAL ROOFING (STEEP SLOPE) SYSTEMS

Construction: All Lead

Application: Any Climate and Primarily for any LONG Lasting Roofing Systems

Plumbers Flashing - Adjustable

Item Number Size Dimensions

LA150S	1"	10x10x12
LA225S	1 1/2"	10x10x12
LA275S	2"	10x10x12
LA375S	3"	12x12x12
LA475S	4"	12x12x12
LA225P	1 1/2"	10x10x12
LA275P	2"	10x10x12
LA375P	3"	12x12x12
LA475P	4"	12x12x12
LA150T	1"	12x16x12
LA225T	1 1/2"	12x16x12
LA275T	2"	12x16x12
LA375T	3"	12x18x12
LA475T	4"	12x18x12
LA25-225S	1 1/2"	12x12x12
LA25-275S	2"	12x12x12
LA25-375S	3"	12x12x12
LA25-475S	4"	12x12x12
LA25-150	1"	16x16x12
LA25-225	1 1/2"	16x16x12
LA25-275	2"	16x16x12
LA25-375	3"	16x16x12
LA25-475	4"	16x16x12
LA150	1"	18x18x12
LA225	1 1/2"	18x18x12
LA275	2"	18x18x12
LA475	4"	18x18x12



FlashCap® System

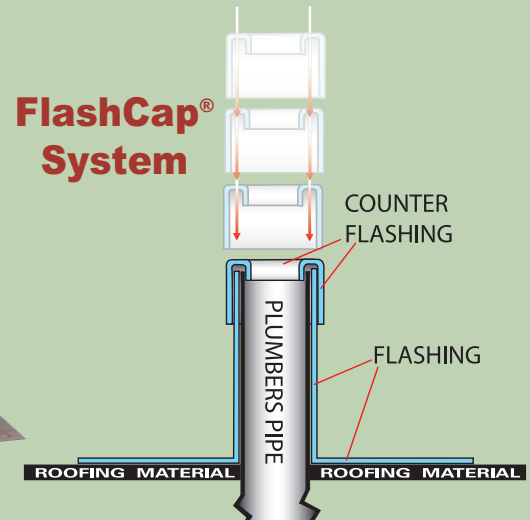

Save time not having to bend lead down into pipe, maximize venting capacity and allows for expansion and contraction.

Counter Flashing for Plumbers Flashings, Adjustable or Cut-to-Pitch

Item Number	Size
LC225	1 1/2"
LC275	2"
LC375	3"
LC475	4"



Complete your counter flashing requirement with FlashCap®

The all-lead cap fits snugly over the flashing and into the vent pipe, while saving the contractor time.

Note: Adjustable flashings not recommended for pitches exceeding a 4/12 pitch. Other base sizes and riser heights can be manufactured per your specifications.

Plumbers Flashing Cut-to-Pitch

Item Number	Size	Dimensions
LP150	1"	12x12x12
LP225	1 1/2"	12x12x12
LP275	2"	12x12x12
LP375	3"	12x12x12
LP475	4"	12x12x12

Note: Specify pitch.



Counter Flashing for Plumbers Flashings, Adjustable or Cut-to-Pitch

Item Number	Size
LC225	1 1/2"
LC275	2"
LC375	3"
LC475	4"



Complete your counter flashing requirement with FlashCap®

The all-lead cap fits snugly over the flashing and into the vent pipe, while saving the contractor time.



FlashCap® System

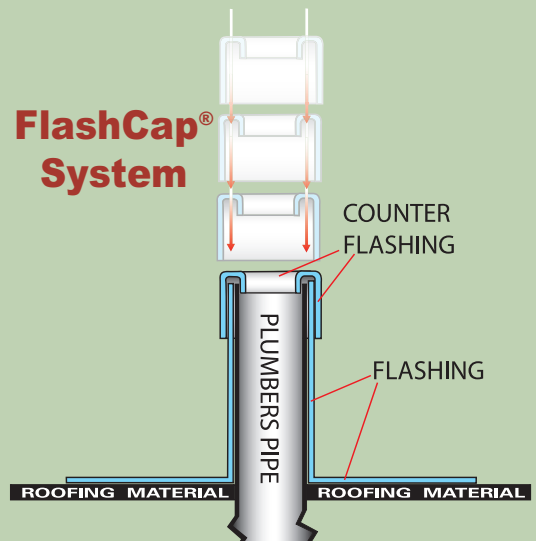

Save time not having to bend lead down into pipe, maximize venting capacity and allows for expansion and contraction.



ROOF FLASHINGS AND ACCESSORIES FOR RESIDENTIAL ROOFING (STEEP SLOPE) SYSTEMS

Construction: Lead Based Flashings with Galvanized Steel Riser
 Application: Mild Climate and Primarily for Tile Roofing Systems

Plumbers Flashings - Standard Base

Item Number	Size	Base Dimensions
LG1018	1"	18" x 18"
LG1518	1 1/2"	18" x 18"
LG2018	2"	18" x 18"
LG3020P	3"	18" x 20"
LG4018P	4"	18" x 24"
LG5024P	5"	24" x 24"
LG6024P	6"	24" x 24"

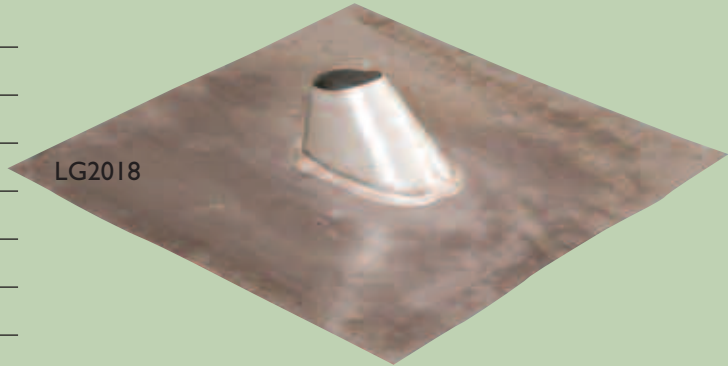

Plumbers Flashings - Large Base

Item Number	Size	Base Dimensions
LG1022	1"	22" x 21"
LG1522	1 1/2"	22" x 21"
LG2022	2"	22" x 21"
LG3024P	3"	24" x 23"
LG4024P	4"	24" x 24"
LG5026P	5"	26" x 26"
LG6026P	6"	26" x 26"

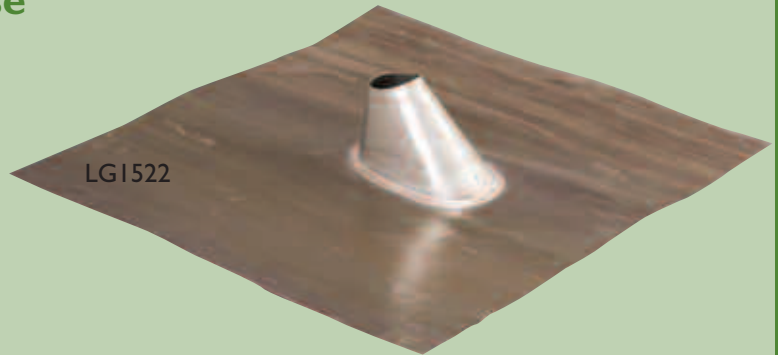

Pipe Collars

Item Number	Size
PC-100	1"
PC-150	1 1/2"
PC-200	2"
PC-300	3"
PC-400	4"

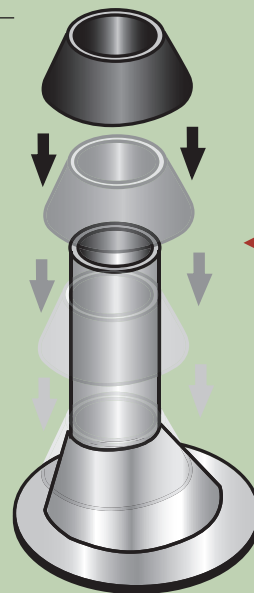

Use Pipe Collar as Counter Flashing for Conical Plumbers Flashings.

EXHAUST FLASHINGS

Fan Exhaust Flashings, Two Piece

Item Number	Size	Base Dimensions
LG4F	4" Base	26" x 24"
LG6F	6" Base	27" x 26"
LG8F	8" Base	28" x 26"
LG10F	10" Base	30" x 28"
LG12F	12" Base	32" x 30"

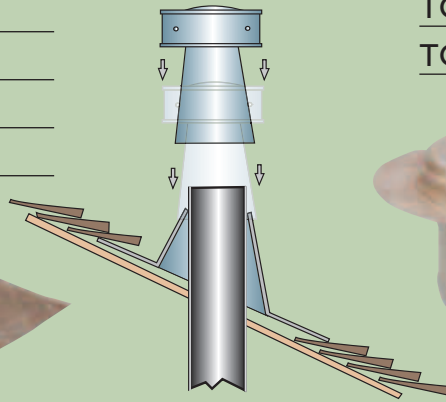
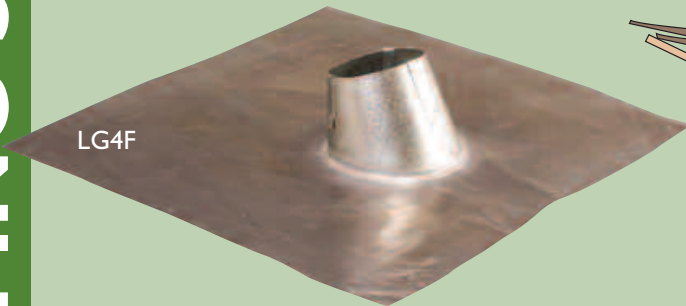

Tops

TG40	4" Top
TG60	6" Top
TG80	8" Top
TG10	10" Top
TG12	12" Top



Heated Exhaust Flashings, Two Piece

Item Number	Size	Base Dimensions
LG3024	3" Std. Base	24" x 24"
LG3026	3" Lg. Base	26" x 26"
LG4024	4" Std. Base	24" x 24"
LG4028	4" Lg. Base	28" x 26"
LG5028	5" Lg. Base	28" x 26"
LG6026	6" Std. Base	26" x 24"
LG6030	6" Lg. Base	30" x 28"
LG7032	7" Lg. Base	32" x 30"
LG8028	8" Std. Base	28" x 26"
LG8032	8" Lg. Base	32" x 30"
LG1032	10" Lg. Base	32" x 30"
LG1232	12" Lg. Base	32" x 30"



Tops

Item Number	Size
TA30	3" Top
TA40	4" Top
TA50	5" Top
TA60	6" Top
TA70	7" Top
TA80	8" Top
TA10	10" Top
TA12	12" Top



Fan Exhaust Flashings, One Piece T-Tops

Item Number	Size	Base Dimensions
LG4T	4" Std.	18" x 20"
LG4TL	4" Lg.	22" x 24"
LG7T	7" Std.	22" x 20"
LG7TL	7" Lg.	26" x 25"



VENT FLASHINGS AND ACCESSORIES

Roof Vent Flashings

Item Number	Size/Description	Base Dimensions
LG972	100si Half Round Dormer with Lead Front.	9" Skirt
LG973	100si Half Round Dormer with Lead Front & Sides	9" Skirt
LG976	50si Eyebrow Vent with Lead Front & Sides	9" Skirt

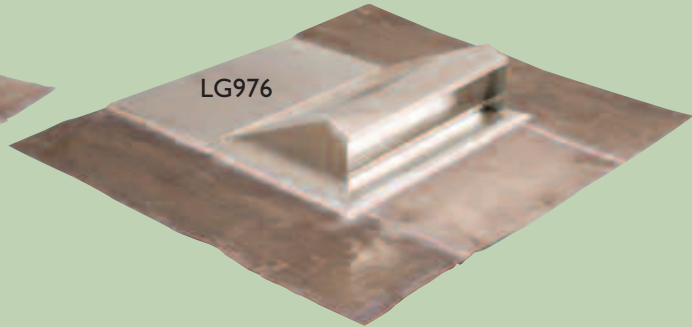
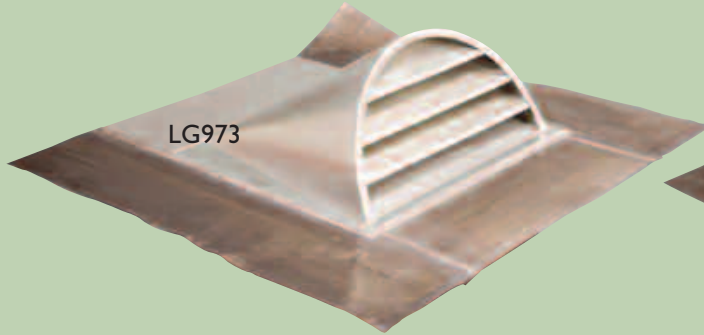

Roof Vent Flashings

LG4JVN	4" Std. Base J Vent	18" x 18"
LG4JVNL	4" Lg. Base J Vent	24" x 24"
LG8JV	8" Std. Base J Vent	22" x 22"
LG8JVL	8" Lg. Base J Vent	26" x 26"
LG12JV	12" Std. Base J Vent	24" x 24"
LG12JVL	12" Lg. Base J Vent	32" x 32"
LRC4_ _ _	4" Roof Cap Vent	18" x 18"
LRC6_ _ _	6" Roof Cap Vent	20" x 20"
LRV_ _ _	38si Roof Vent	18" x 18"
LGRVO38P	38si Roof Vent, Primed	18" x 18"

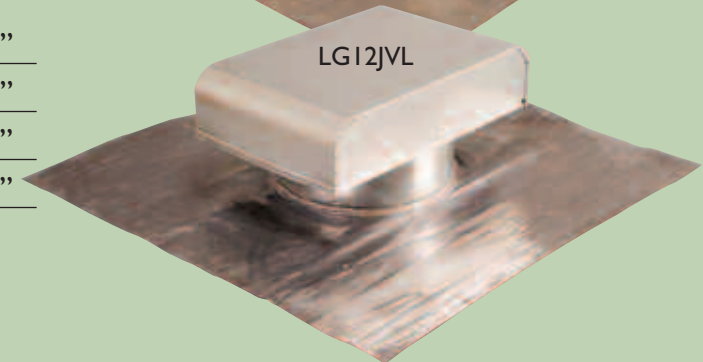
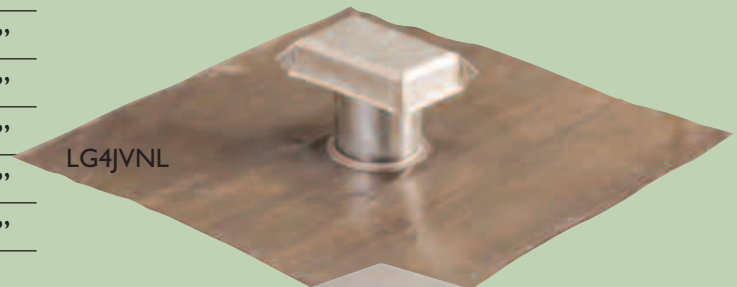

Available in Black, Brown or Gray
Specify Color (LRC4_ _ _): Blk, Brn, Gry

Roof Accessories

Item Number	Size/Description
LG950	6" Right/Left Corner Flashing
LG965	4" x 8" x 5" Roof to Wall

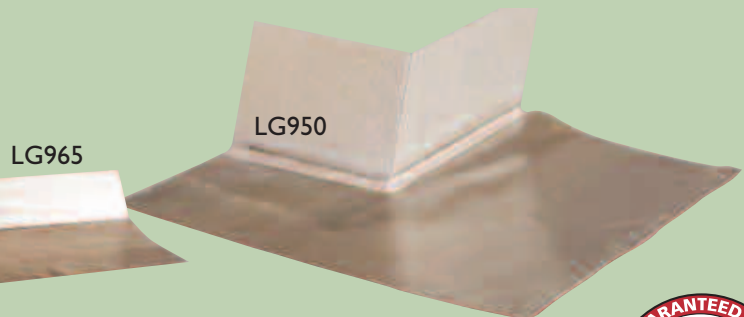

CUSTOM ROOF FLASHINGS AND ACCESSORIES

Construction: Lead Based Flashings with Copper Riser

Application: Primarily for Tile Roofing Systems and Coastal Areas

Plumbers Flashings - Large Base

Item Number	Size	Base Dimensions
LC1022	1"	22" x 21"
LC1522	1 1/2"	22" x 21"
LC2022	2"	22" x 21"
LC3024P	3"	24" x 23"
LC4024P	4"	24" x 24"
LC5026P	5"	26" x 26"
LC6026P	6"	26" x 26"



LC2022

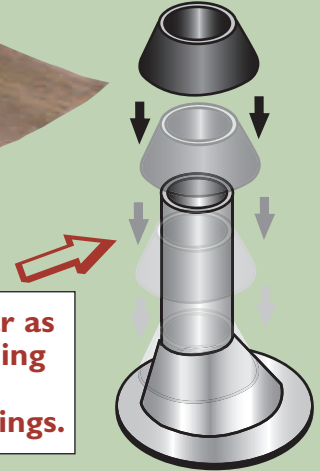

Use Pipe Collar as Counter Flashing for Conical Plumbers Flashings.

Exhaust Flashings

Item Number	Size	Base Dimensions
LC3026	3" Lg. Base	26" x 26"
LC4028	4" Std. Base	24" x 24"
LC5028	5" Lg. Base	28" x 26"
LC6030	6" Lg. Base	30" x 28"
LC7032	7" Lg. Base	32" x 30"
LC8032	8" Lg. Base	32" x 30"



LC-4028

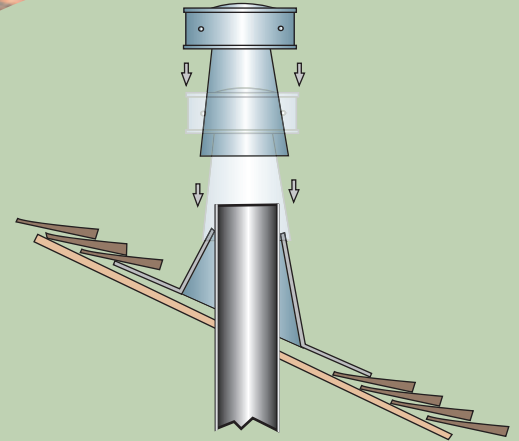

Tops

CU30T	3" Top, Tall
CU40S	4" Top, Short
CU40T	4" Top, Tall
CU50T	5" Top, Tall
CU60S	6" Top, Short
CU60T	6" Top, Tall
CU70T	7" Top, Tall
CU80S	8" Top, Short
CU80T	8" Top, Tall



CU-40S

CU-40T

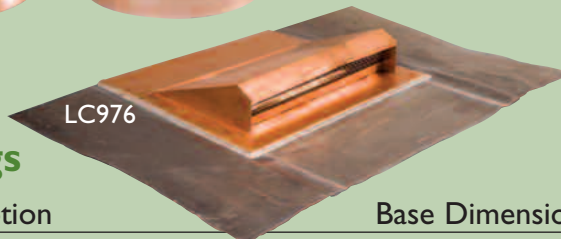

LC976

Roof Vent Flashings

Item Number	Size/Description	Base Dimensions
LC976	50si Eyebrow Vent with Lead Front & Sides	9" Skirt
LCRVO38	38si Roof Vent, Copper	18" x 18"

